

# TS 100

**Up View**

Steering Cylinder

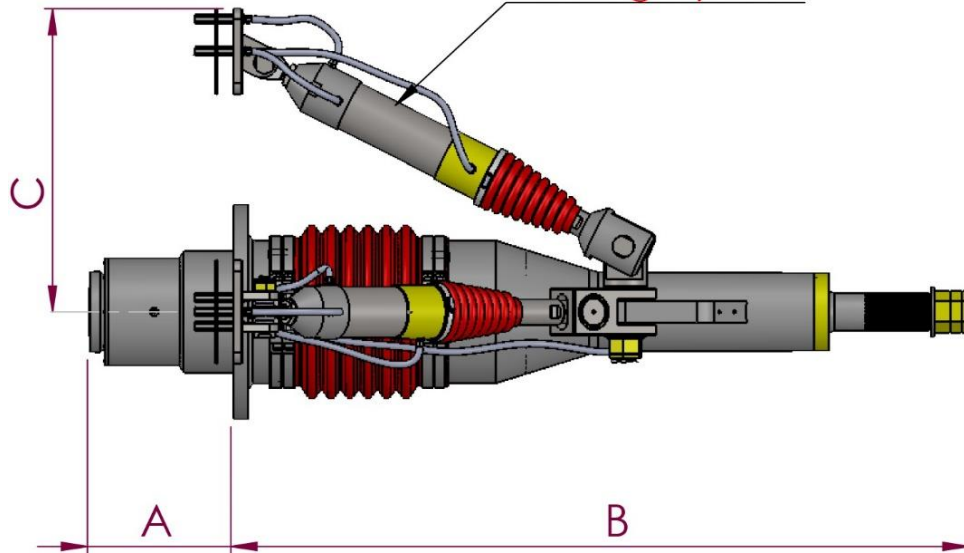

**Side View**

Trim Cylinder

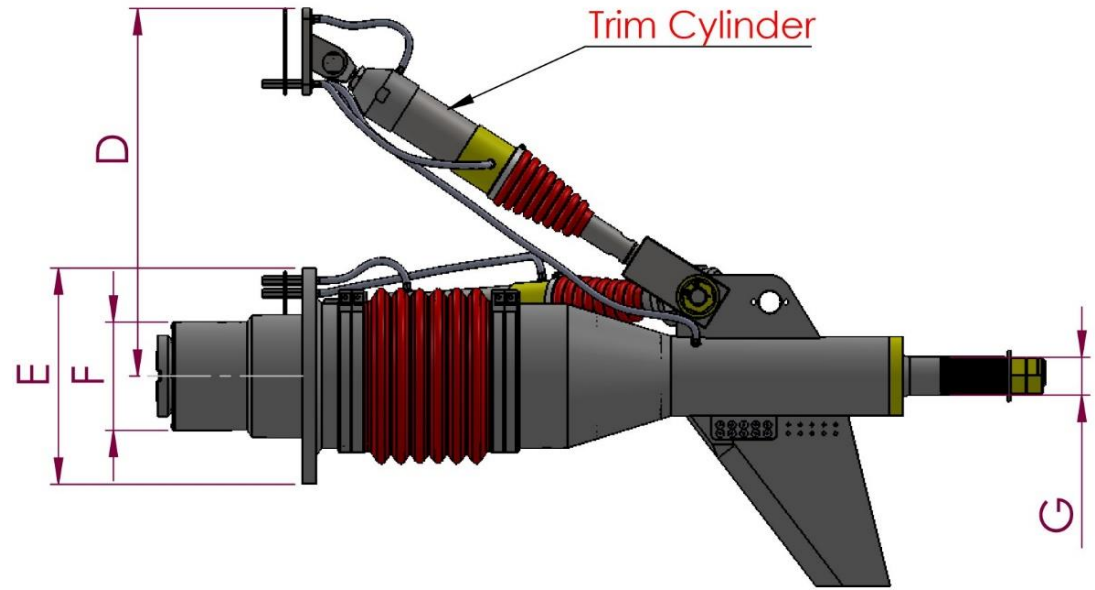

Max Torque Input : 20.500Nm

<b>A</b>	403 mm
<b>B</b>	2070 mm
<b>C</b>	850 mm
<b>D</b>	1020mm
<b>E</b>	600 mm
<b>F</b>	340 mm
<b>G</b>	Z 32