

TS 50

Up View

Steering Cylinder

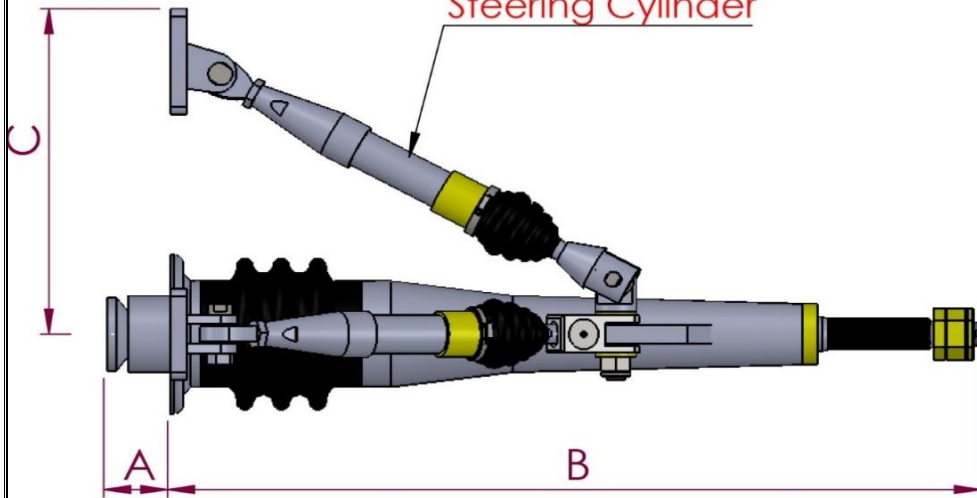

Side View

Trim Cylinder

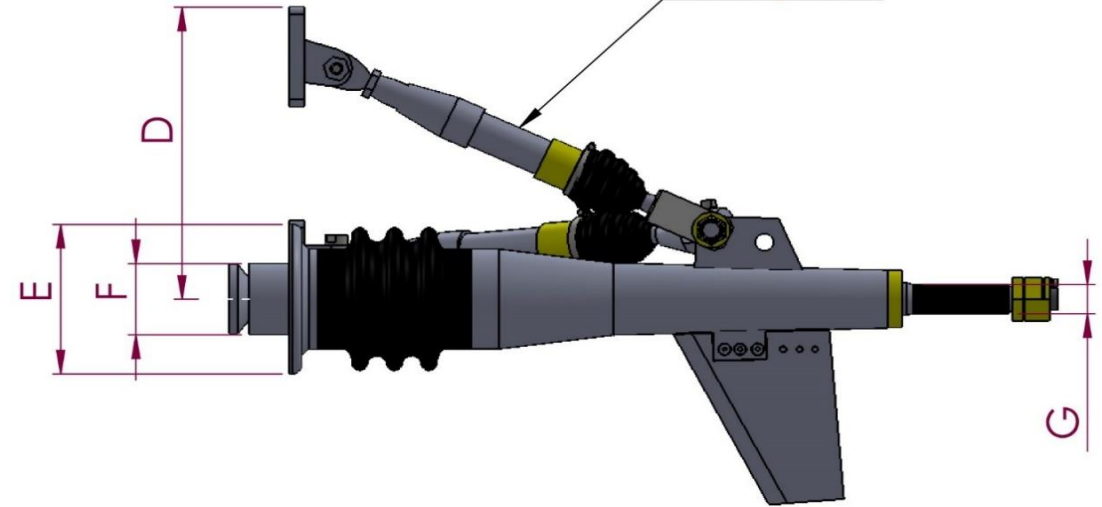

Max Torque Input : 2.000Nm

A	172 mm
B	1175 mm
C	336 mm
D	496 mm
E	270 mm
F	132 mm
G	Z 25