

# TS 75

**Up View**

Steering Cylinder

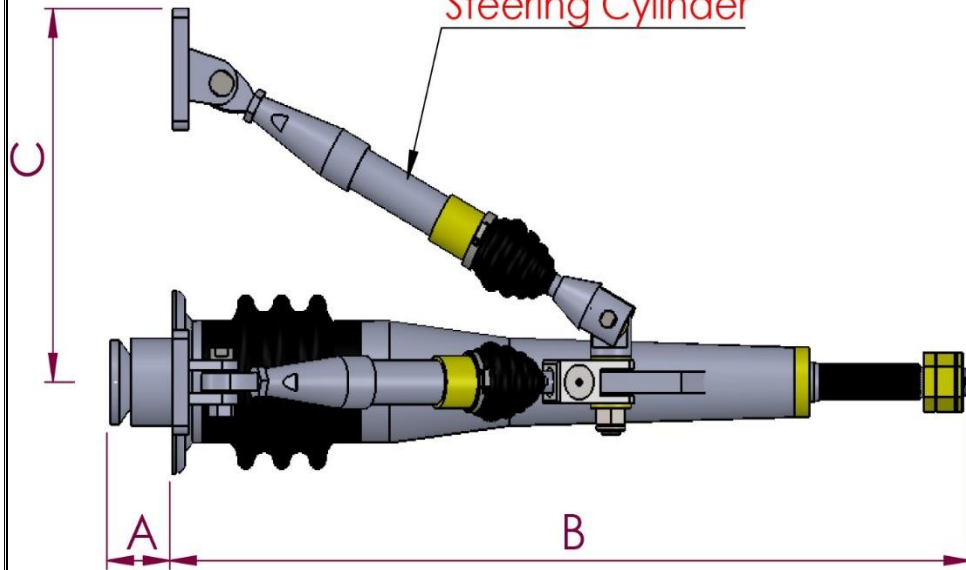

**Side View**

Trim Cylinder

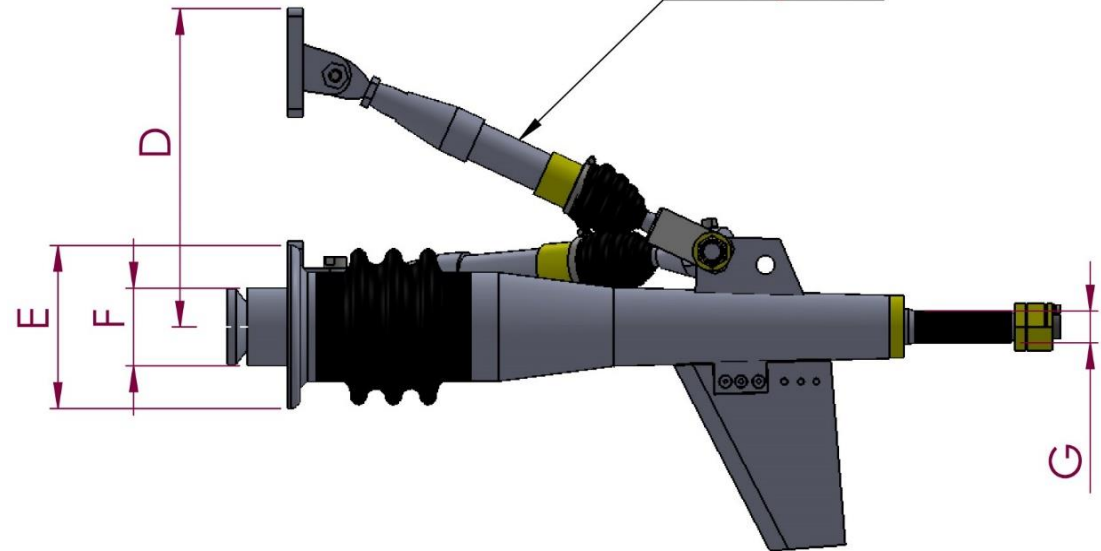

Max Torque Input : 7.300Nm

<b>A</b>	170 mm
<b>B</b>	1600 mm
<b>C</b>	722 mm
<b>D</b>	675mm
<b>E</b>	330 mm
<b>F</b>	170 mm
<b>G</b>	Z 36